

 **BIS 8,5 t**  
**ACHSLAST**

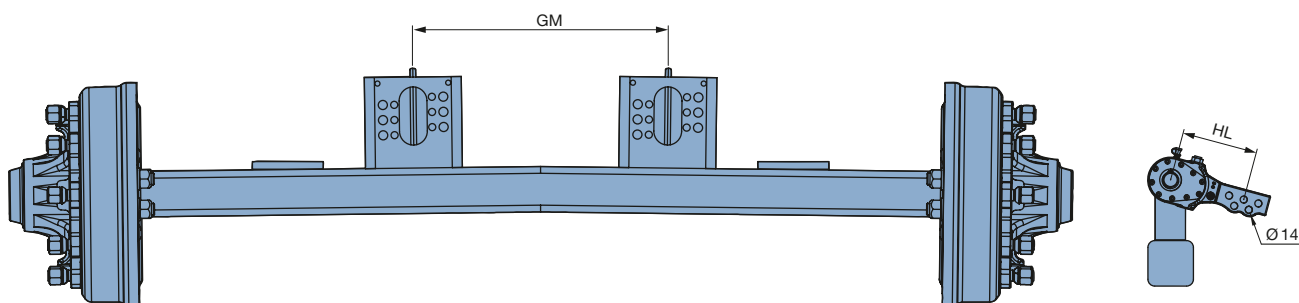

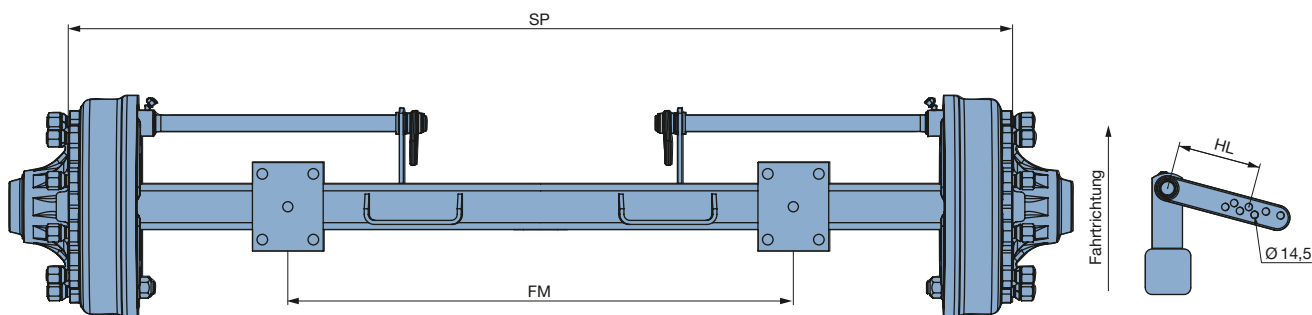



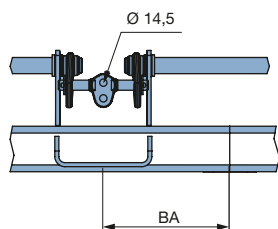

HL: 120/135/150/165/180









HL: 120/135/150/165/180/200



# BPW BREMSACHSEN MIT MASSIVACHSKÖRPER. STATISCHE ACHSLASTEN BIS 8.5 t (TANDEM).

Achsquerschnitt (mm)	Spurweite SP (mm)	Federmitte FM (mm)	Grundplatten- mitte GM (mm)	Bremsausgleich	Statische Achslast (kg)						BPW Sachnummer
					25 km/h			40 km/h			
											
<b>GS 4006 - Achslast bis 4.000 kg (25 km/h)</b>											
<b>Bremse N3006-3 - 300 x 60 mm - Radanschluss 160/205/6 ET 0 - M18 x 1,5</b>											
60	1.500	1.000		MV	4.500	3.800	-	4.100	3.500	-	55.56.443.601
60	1.700	1.200	576	ohne	4.500	3.800	-	4.100	3.500	-	55.56.443.604
60	1.700	1.200		MV	4.500	3.800	-	4.100	3.500	-	55.56.443.605
60	1.800	1.300	676	ohne	4.500	3.800	-	4.100	3.500	-	55.56.443.608
60	1.800	1.300		MV	4.500	3.800	-	4.100	3.500	-	55.56.443.609
<b>GS 5506 - Achslast bis 5.500 kg (25 km/h)</b>											
<b>Bremse N3006-3 - 300 x 60 mm - Radanschluss 160/205/6 ET 0 - M18 x 1,5</b>											
70	1.360	860	232	ohne	7.000	6.000	5.500	6.500	5.500	5.000	55.63.443.609
70	1.500	1.000	372	ohne	7.000	6.000	5.500	6.500	5.500	5.000	55.63.443.600
70	1.500	1.000		MV	7.000	6.000	5.500	6.500	5.500	5.000	55.63.443.601
70	1.650	1.150	522	ohne	7.000	6.000	5.500	6.500	5.500	5.000	55.63.443.610
70	1.650	1.150		MV	7.000	6.000	5.500	6.500	5.500	5.000	55.63.443.615
70	1.700	1.200	572	ohne	7.000	6.000	5.500	6.500	5.500	5.000	55.63.443.604
70	1.700	1.200		MV	7.000	6.000	5.500	6.500	5.500	5.000	55.63.443.605
70	1.800	1.300	672	ohne	7.000	6.000	5.500	6.500	5.500	5.000	55.63.443.611
<b>GS 5506 - Achslast bis 5.500 kg (25 km/h)</b>											
<b>Bremse N3108-3 - 310 x 80 mm - Radanschluss 160/205/6 ET 0 - M18 x 1,5</b>											
70	1.500	1.000	300	ohne	7.000	6.000	5.500	6.500	5.500	5.000	55.63.454.600
70	1.500	1.000		MV	7.000	6.000	5.500	6.500	5.500	5.000	55.63.454.601
70	1.700	1.200	500	ohne	7.000	6.000	5.500	6.500	5.500	5.000	55.63.454.604
70	1.700	1.200		MV	7.000	6.000	5.500	6.500	5.500	5.000	55.63.454.605
70	1.850	1.350	650	ohne	7.000	6.000	5.500	6.500	5.500	5.000	55.63.454.608
70	1.850	1.350		MV	7.000	6.000	5.500	6.500	5.500	5.000	55.63.454.609
<b>GS 5508 - Achslast bis 5.500 kg (25 km/h)</b>											
<b>Bremse N3108-3 - 310 x 80 mm - Radanschluss 220/275/8 ET 0 - M20 x 1,5</b>											
70	1.500	1.000	300	ohne	7.000	6.000	5.500	6.500	5.500	5.000	55.63.454.612
70	1.500	1.000		MV	7.000	6.000	5.500	6.500	5.500	5.000	55.63.454.613
70	1.700	1.200	500	ohne	7.000	6.000	5.500	6.500	5.500	5.000	55.63.454.616
70	1.700	1.200		MV	7.000	6.000	5.500	6.500	5.500	5.000	55.63.454.617
70	1.850	1.350	650	ohne	7.000	6.000	5.500	6.500	5.500	5.000	55.63.454.620
70	1.850	1.350		MV	7.000	6.000	5.500	6.500	5.500	5.000	55.63.454.621
<b>GS 7008 - Achslast bis 7.000 kg (25 km/h)</b>											
<b>Bremse N3108-3 - 310 x 80 mm - Radanschluss 220/275/8 ET 0 - M20 x 1,5</b>											
80	1.700	1.100	500	ohne	9.000	7.500	7.000	8.000	7.000	6.500	55.67.454.608
80	1.850	1.250	650	ohne	9.000	7.500	7.000	8.000	7.000	6.500	55.67.454.600
80	1.850	1.250		MV	9.000	7.500	7.000	8.000	7.000	6.500	55.67.454.601
80	1.950	1.350	750	ohne	9.000	7.500	7.000	8.000	7.000	6.500	55.67.454.604
80	1.950	1.350		MV	9.000	7.500	7.000	8.000	7.000	6.500	55.67.454.605
80	2.050	1.450	850	ohne	9.000	7.500	7.000	8.000	7.000	6.500	55.67.454.609

Angeschweißte Grundplatten sind serienmäßig enthalten.  
Angeschweißte Federplatten sind Option.

Achsquerschnitt (mm)	Spurweite SP (mm)	Federmitte FM (mm)	Grundplatten- mitte GM (mm)	Bremsausgleich	Statische Achslast (kg)						BPW Sachnummer
					25 km/h			40 km/h			
											

**GS 7008 - Achslast bis 7.000 kg (25 km/h)**

**Bremse N4008-4 - 400 x 80 mm - Radanschluss 220/275/8 ET 0 - M20 x 1,5**

80	1.800	1.200	450	ohne	9.000	7.500	7.000	8.000	7.000	6.500	55.67.461.600
80	1.800	1.200		MV	9.000	7.500	7.000	8.000	7.000	6.500	55.67.461.601
80	1.850	1.250	500	ohne	9.000	7.500	7.000	8.000	7.000	6.500	55.67.461.604
80	1.850	1.250		MV	9.000	7.500	7.000	8.000	7.000	6.500	55.67.461.605
80	2.000	1.400	650	ohne	9.000	7.500	7.000	8.000	7.000	6.500	55.67.461.608
80	2.000	1.400		MV	9.000	7.500	7.000	8.000	7.000	6.500	55.67.461.609

**GS 8008-1 - Achslast bis 8.500 kg (25 km/h)**

**Bremse N3108-3 - 310 x 80 mm - Radanschluss 220/275/8 ET 0 - M20 x 1,5**

90	1.800	1.200	600	ohne	11.000	9.500	8.500	10.000	8.500	8.000	55.70.454.600
90	1.800	1.200		MV	11.000	9.500	8.500	10.000	8.500	8.000	55.70.454.601
90	1.950	1.350	750	ohne	11.000	9.500	8.500	10.000	8.500	8.000	55.70.454.604
90	1.950	1.350		MV	11.000	9.500	8.500	10.000	8.500	8.000	55.70.454.605
90	2.050	1.450	850	ohne	11.000	9.500	8.500	10.000	8.500	8.000	55.70.454.608
90	2.050	1.450		MV	11.000	9.500	8.500	10.000	8.500	8.000	55.70.454.609

**GS 8008-3 - Achslast bis 8.500 kg (25 km/h)**

**Bremse N4008-4 - 400 x 80 mm - Radanschluss 220/275/8 ET 0 - M20 x 1,5**

90	1.850	1.250	500	ohne	11.000	9.500	8.500	10.000	8.500	8.000	55.70.461.600
90	1.850	1.250		MV	11.000	9.500	8.500	10.000	8.500	8.000	55.70.461.601
90	1.950	1.350	600	ohne	11.000	9.500	8.500	10.000	8.500	8.000	55.70.461.604
90	1.950	1.350		MV	11.000	9.500	8.500	10.000	8.500	8.000	55.70.461.605
90	2.000	1.400	650	ohne	11.000	9.500	8.500	10.000	8.500	8.000	55.70.461.608
90	2.000	1.400		MV	11.000	9.500	8.500	10.000	8.500	8.000	55.70.461.609
90	2.050	1.450	700	ohne	11.000	9.500	8.500	10.000	8.500	8.000	55.70.461.612
90	2.050	1.450		MV	11.000	9.500	8.500	10.000	8.500	8.000	55.70.461.613

**GS 8010-3 - Achslast bis 8.500 kg (25 km/h)**

**Bremse N4008-4 - 400 x 80 mm - Radanschluss 280/335/10 ET 0 - M22 x 1,5**

90	1.850	1.250	500	ohne	11.000	9.500	8.500	10.000	8.500	8.000	55.70.461.616
90	1.850	1.250		MV	11.000	9.500	8.500	10.000	8.500	8.000	55.70.461.617
90	1.950	1.350	600	ohne	11.000	9.500	8.500	10.000	8.500	8.000	55.70.461.620
90	1.950	1.350		MV	11.000	9.500	8.500	10.000	8.500	8.000	55.70.461.621
90	2.000	1.400	650	ohne	11.000	9.500	8.500	10.000	8.500	8.000	55.70.461.624
90	2.000	1.400		MV	11.000	9.500	8.500	10.000	8.500	8.000	55.70.461.625
90	2.050	1.450	700	ohne	11.000	9.500	8.500	10.000	8.500	8.000	55.70.461.628
90	2.050	1.450		MV	11.000	9.500	8.500	10.000	8.500	8.000	55.70.461.629

Angeschweißte Grundplatten sind serienmäßig enthalten.  
 Bremsausgleich wahlweise mittig vorn, 250 mm links vorn und 250 mm rechts vorn möglich.  
 Standard-Einpresstiefe: ET 0 mm.  
 Weitere Ausführungen auf Anfrage.  
 Wahlweise mit angeschweißten Federplatten.